



Termomeccanica Industrial Process

Termomeccanica Group



# Solvent recovery

February 2016

ООО «ТИ-СИСТЕМС» ИНЖИНИРИНГ И ПОСТАВКА ТЕХНОЛОГИЧЕСКОГО ОБОРУДОВАНИЯ  
Интернет: [www.tisys.ru](http://www.tisys.ru) [www.tisys.kz](http://www.tisys.kz) [www.tisys.by](http://www.tisys.by) [www.tesec.ru](http://www.tesec.ru) [www.ти-системс.рф](http://www.ти-системс.рф)  
Телефоны: +7 (495) 7774788, 7489626, 5007155, 54 Эл. почта: [info@tisys.ru](mailto:info@tisys.ru) [info@tisys.kz](mailto:info@tisys.kz) [info@tisys.by](mailto:info@tisys.by)

# Solvent recovery

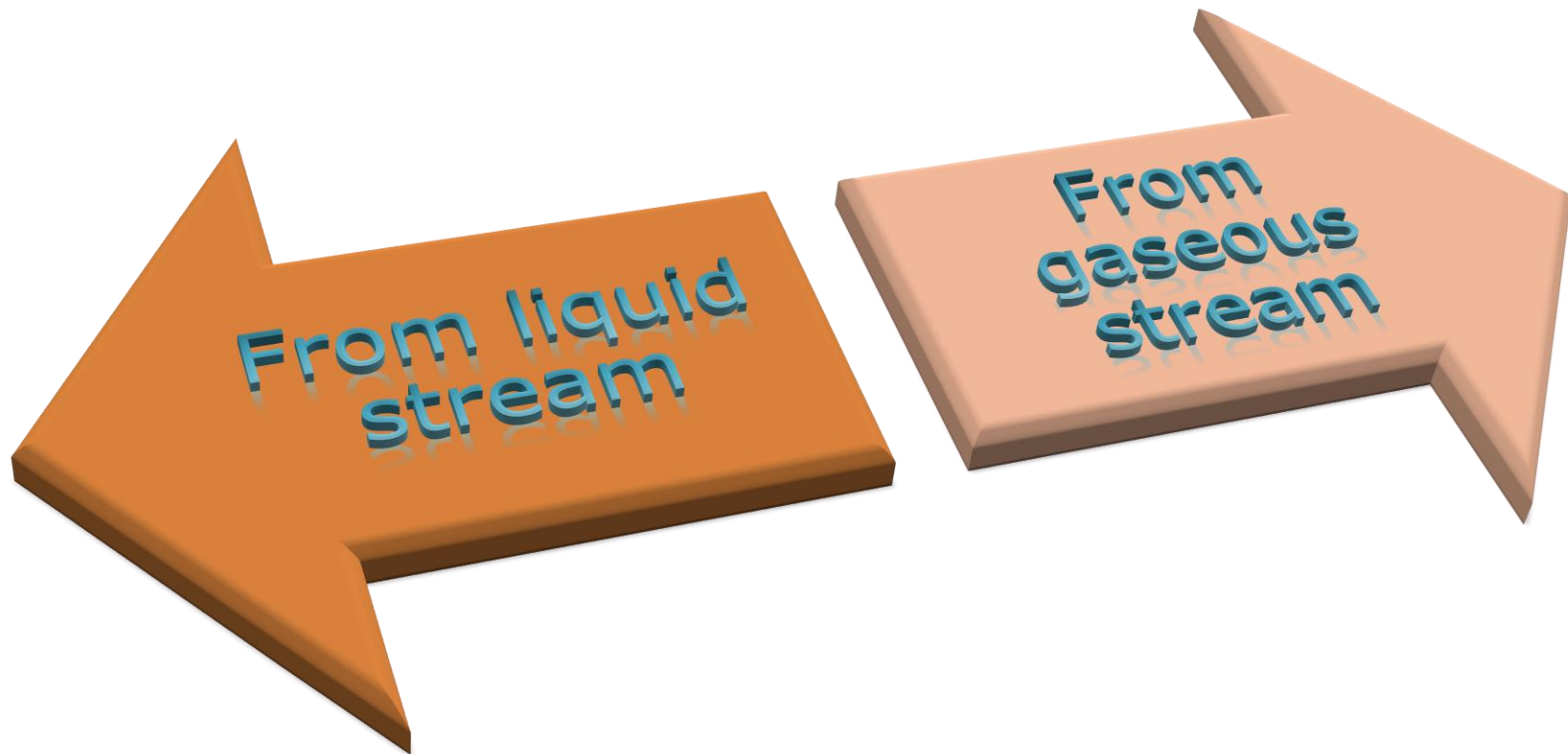

# from liquid stream: Distillation

In many pharmaceutical, chemical and textile processes, solvents are used as solvent mixtures or as water solutions. Solvents can ("must") be recovered.

TMIP manufactures both batch and continuous distillation plants suitable for the above mentioned process. Discontinuous (batch) units are normally used for recovering solvents from complex mixtures, usually present in pharmaceutical industry.

Continuous distillers are aimed at chemical industries.

TMIP distillation plants include units for operating under pressure or vacuum, double or triple effect, with yields above 95% and controlled by some of the most sophisticated control systems available.

	Chemical industry in general
	Paints production
	Synthetic leather production
	Resins production
	Pharmaceutical industry and related material (API)

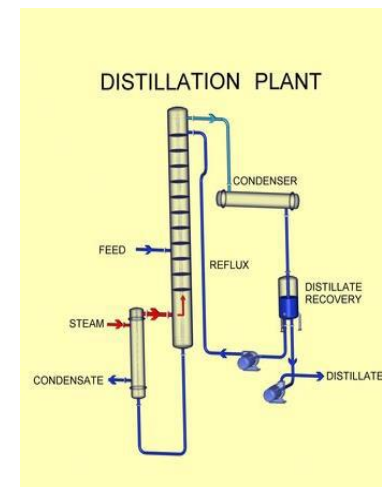

# Distillation

Typical recovered compounds:

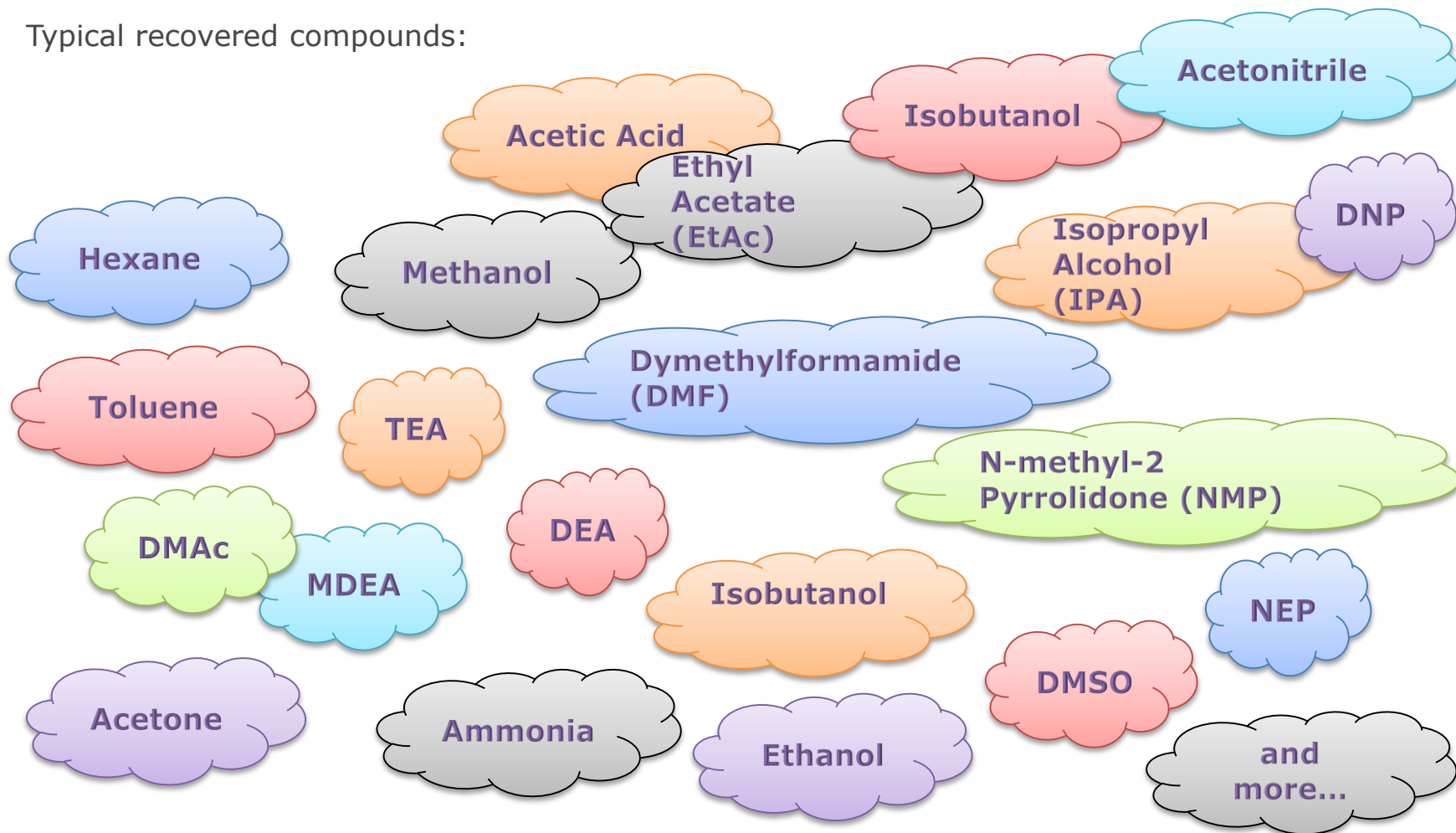

# Distillation

The distillation process cannot always be optimized in a theoretical way. In some cases the presence of substances deriving from the proprietary production process that generated the pollutant wastes can hinder and/or limit distillation.

## Process Solution

- Continuous Distillation
- Batch Distillation
- Azeotropic Distillation
- Extractive Distillation
- Vacuum Distillation
- High pressure Distillation
- With Mechanical Compression
- With Thermocompression
- Multiple effects

TMIP offers its distillation experience in order to recover the solvents into the original process or other process.



# Ethanol –water

## Process Data

- **Operation:**  
Continuous Double Effects
- **Type:** Sieve Trays
- **Capacity:** 3000 kg/h
- **Operating pressure:** Atm
- **Top operating Temperature:**  
78 °C
- **Bottom operating Temperature:**  
100 °C
- **Recovered Ethanol:** >98%
- **Concentration of Recovered Ethanol:** >95% wt.
- **Material of construction:**  
AISI 304 SS

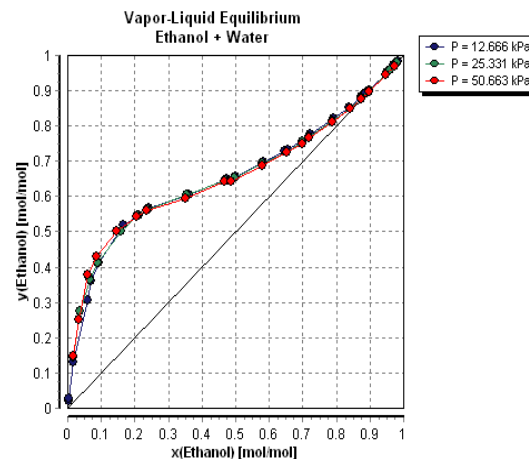
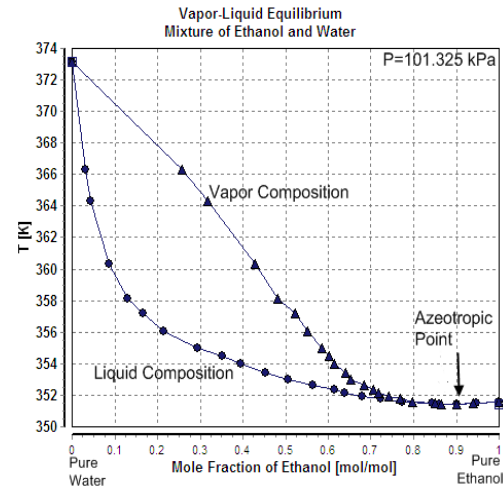

# DMF –water

## Process Data

- **Operation:** Continuous
- **Type:** Sieve Trays
- **Capacity:** up to 9000 kg/h
- **Material of construction:** AISI 316-304 SS
- **Top operating Temperature:** 56°C
- **Bottom operating Temperature:** 105 °C
- **Recovered DMF:** >99%
- **Concentration of Recovered DMF:** 99% wt.
- **Operating pressure:** vacuum



T-x-y Plot for H<sub>2</sub>O and DMF at 0,23 bar

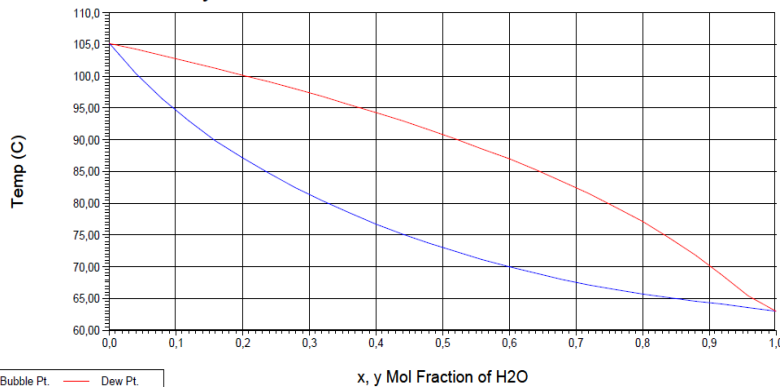

# MC / ACETONE / IPA / TEA-DEA

	MC -water	IPA -water	TEA/DEA –water	ACETONE - water
Operation	Continuous	Continuous	Batch	Continuous/ Batch
Type	Sieve Trays	Sieve Trays	Structured Packing	Structured Packing
Capacity	1500 kg/h	1500 kg/h	800 kg/h	1500 kg/h
Operating pressure	Atm.	Atm.	Atm.	Atm.
Concentration of Recovered Compounds	99% wt	85% wt	99% wt	95% wt 99% wt
Material of construction	AISI 316 SS	AISI 316 SS	Carbon steel, Glass lined Column, Titanium heat exchanger	AISI 316 SS





# IPA –water

## Process Data

- **Operation:** Continuous double effects
- **Type:** Sieve Trays
- **Capacity:** 5000 kg/h
- **IPA inlet concentration:** 50% wt
- **Top operating Temperature:** 80°C
- **Bottom operating Temperature:** 100 °C
- **Recovered IPA:** >98%
- **Concentration of Recovered IPA:** >87% wt.
- **Operating pressure:** atm
- **Material of construction:** AISI 316 SS / HastelloyC22

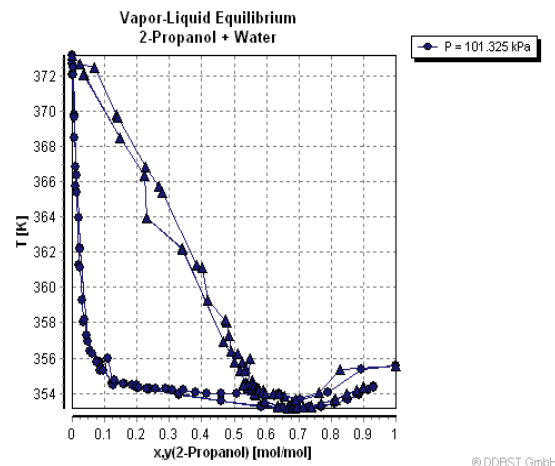
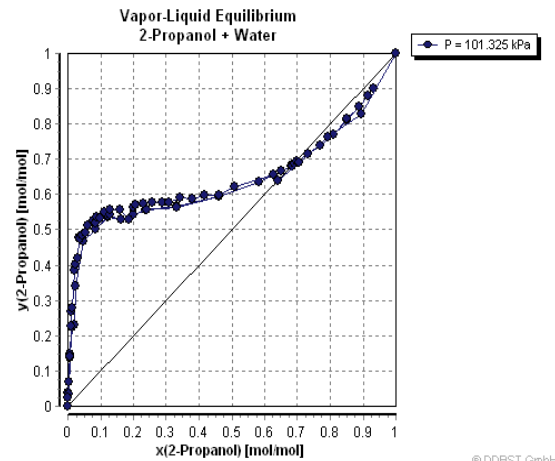

# Ethyl acetate –water

## Process Data

- **Operation:** Continuous
- **Type:** Sieve Trays
- **Capacity:** 1000 kg/h
- **EtAcinlet concentration:** 50% wt
- **Top operating Temperature:** 70°C
- **Bottom operating Temperature:** 100 °C
- **Concentration of Recovered EtAc:** >99% wt.
- **Operating pressure:** atm
- **Material of construction:** AISI 304 SS

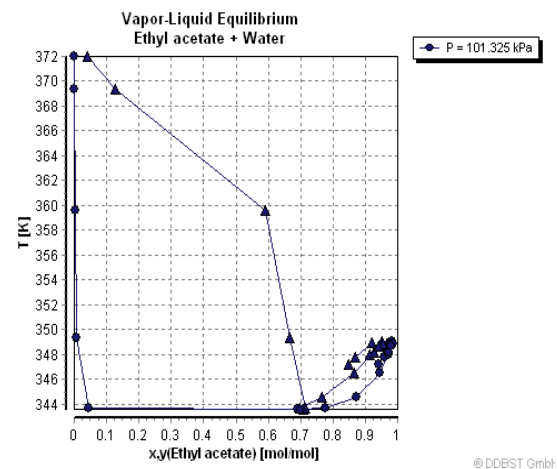
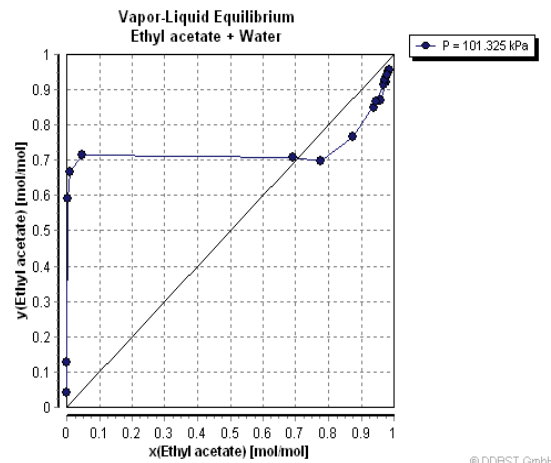



from gaseous stream: Absorption

Solvent  
recovery

Pollutant  
removal

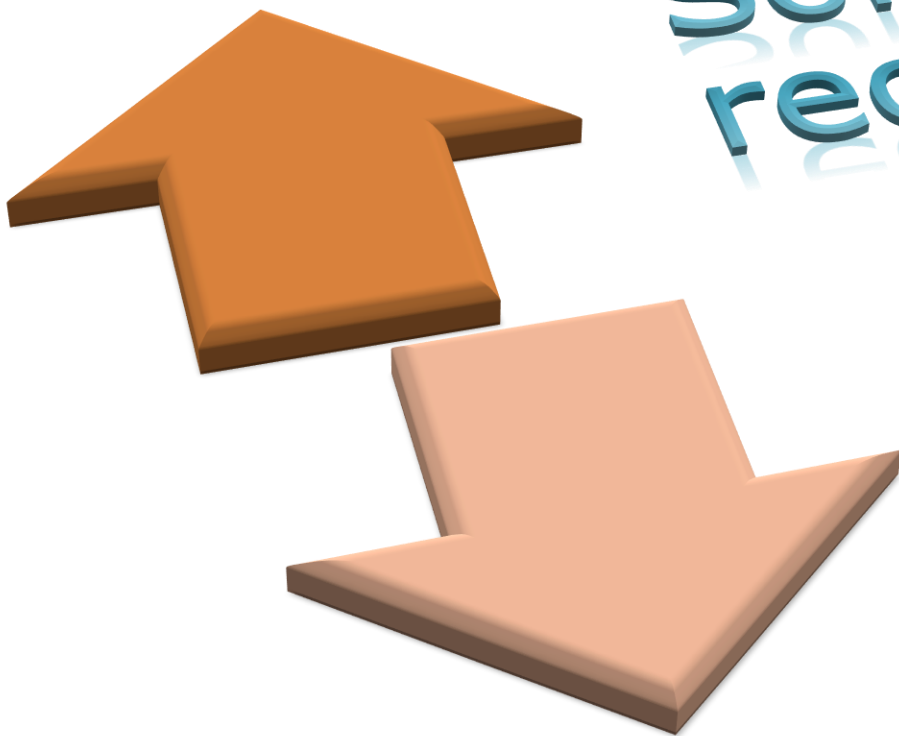

# Absorption: solvent recovery

DMF, NMP is highly soluble in water; T.M.I.P. exploits this characteristic of the soluble water solvent that can be recovered by washing the air in counter current air stream with water in a plates tower. Solvent is collected on the bottom of the tower in solution with water. The solution will be distilled to recover pure solvent.

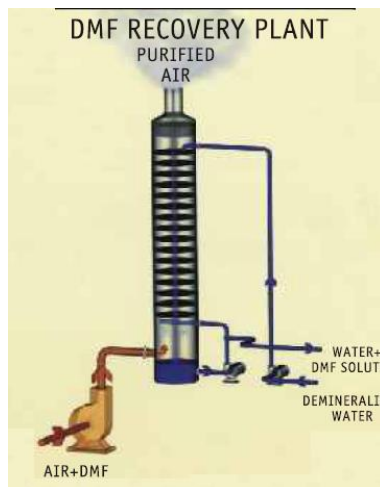

# Absorption: pollutant removal

Pollutants removal takes place through a “washing” process by means of liquid. Particles with diameter  $> 1 \mu\text{m}$  that impact water droplets or wet surface generates the absorption process. A liquid detains small particles by absorption that is the selective passage of one or more gaseous components into liquid phase.

The liquid incorporating the pollutants is then recovered on the bottom of the washing tower and treated.





# from gaseous stream: Adsorption

It's adopted for treating exhaust gas recovering pollutants with the possibility of recycling them in a new process.

Adsorbing materials are micro porous substances with a huge surface/height (up to 1700 m<sup>2</sup>/gr) such as activated carbons, synthetic zeolite, silica gel and activated alumina.

TMIP designs & manufactures adsorption plants with pollutant removal levels of 97% and with a particularly fast investment payback.

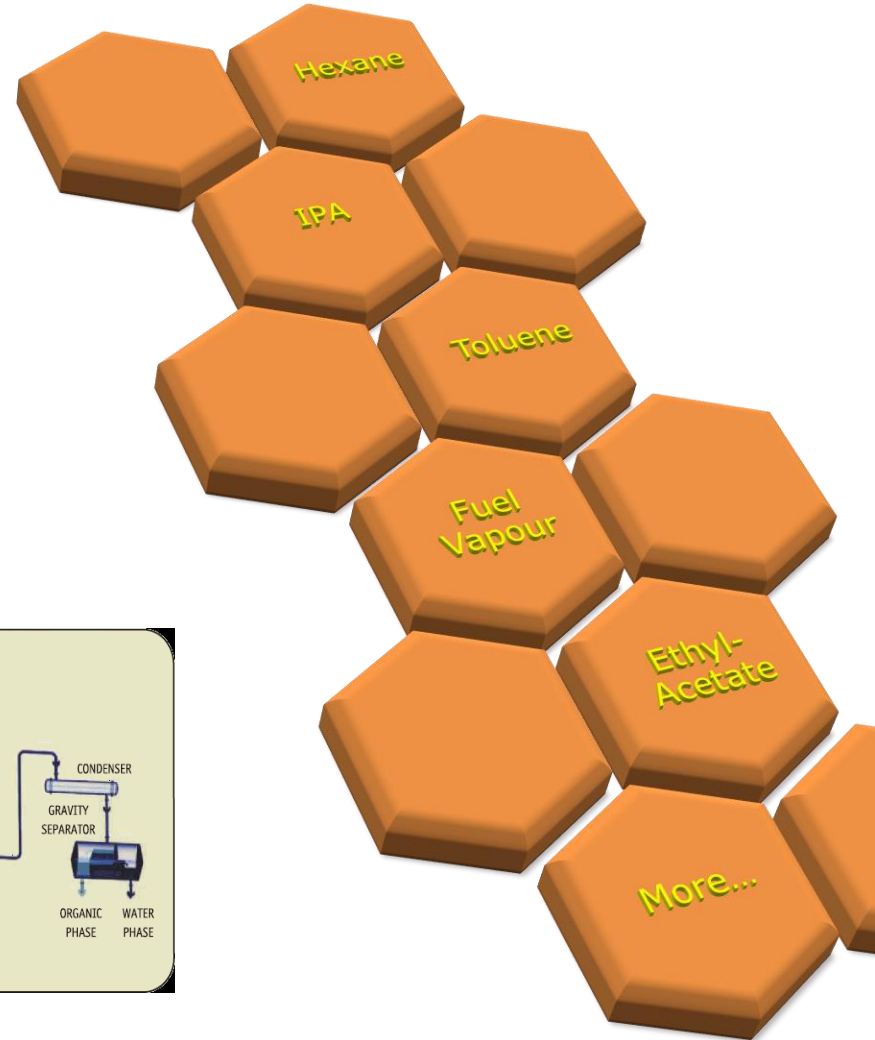

ADHESIVE TAPES  
PRODUCTION



ADHESIVE PAPER  
PRODUCTION



PAINTS  
PRODUCTION



ROTOGRAVURE  
PRINTING

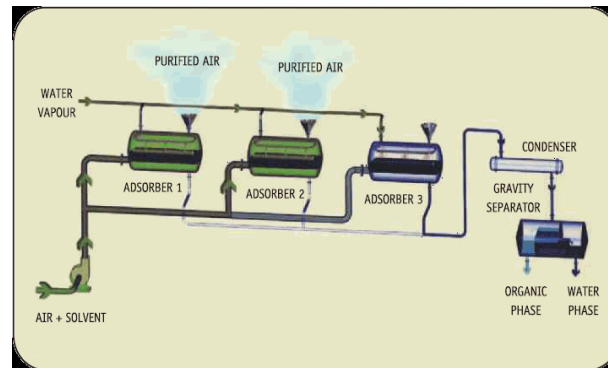

# Adsorption

## Process Solution:

- Activated Carbon regeneration by steam
- Activated Carbon regeneration by hot nitrogen
- with Thermocompression for steam saving
- With Distillation Units

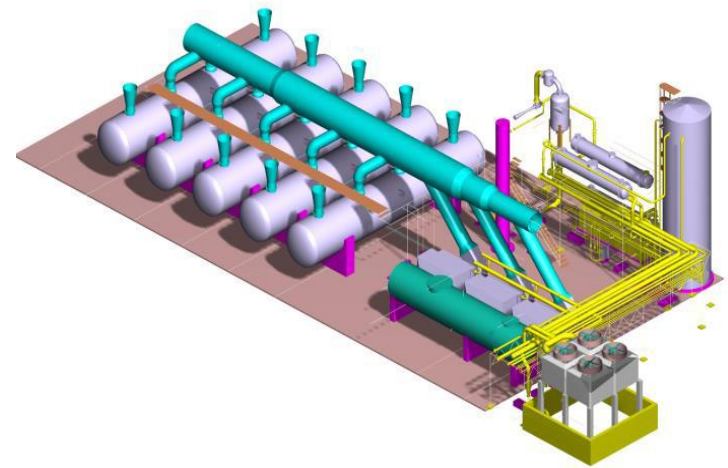

# Hexane recovery

## Process Data

- **Operation:** Continuous
- **Type:** Steam regeneration
- **Capacity:** 200.000 Nm<sup>3</sup>/h
- **Number of adsorbers:** 5
- **Solvent inlet concentration:** 5 g/Nm<sup>3</sup>
- **Recovery percentage:** >96%
- **Steam specific consumption:** 3.5 kg<sub>steam</sub>/kg<sub>solvent</sub>



TYPICAL ADSORBER

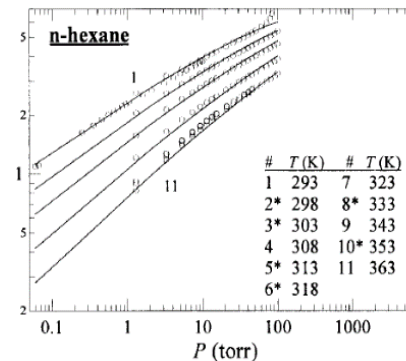
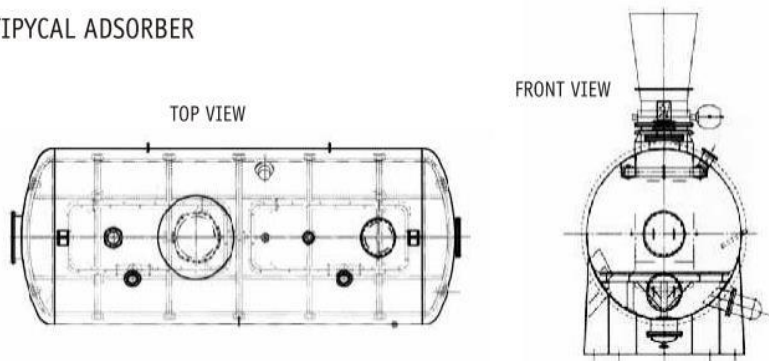



# Toluene recovery

## Process Data

- **Operation:** Continuous
- **Type:** Steam regeneration
- **Capacity:** 200.000 Nm<sup>3</sup>/h
- **Number of adsorbers:** 5
- **Solvent inlet concentration:** 5 g/Nm<sup>3</sup>
- **Recovery percentage:** >96%
- **Steam specific consumption:** 3.5 kg<sub>steam</sub>/kg<sub>solvent</sub>

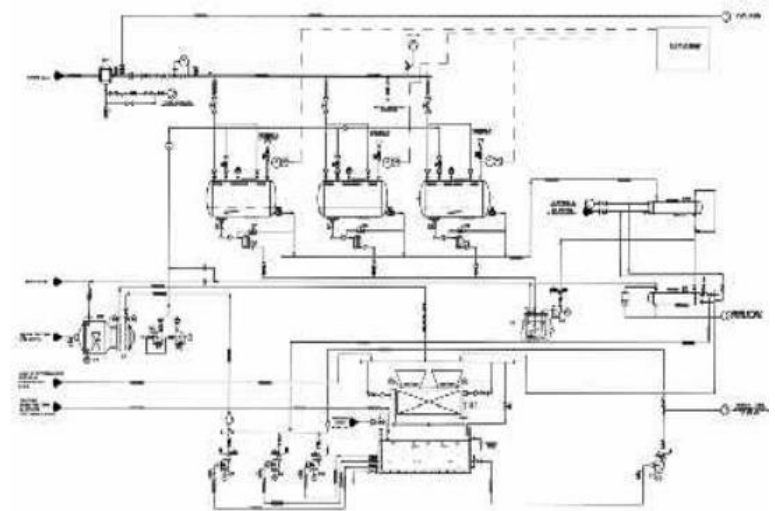

# Ethyl acetate recovery

## Process Data

- **Operation:** Continuous
- **Type:** Steam regeneration and Ethyl acetate water mixer distillation
- **Capacity:** 80.000 Nm<sup>3</sup>/h
- **Number of adsorbers:** 3
- **Solvent inlet concentration:** 8 g/Nm<sup>3</sup>
- **Recovery percentage:** >96%
- **Steam specific consumption:** 3 kg<sub>steam</sub>/kg<sub>solvent</sub>



# Vapour Recovery Unit

The main advantages for recovering vapours are:

- Reduce emission of environmentally hazardous compounds;
- Increase safety and reduce health risks linked with the distribution net of gasoline or crude oil;
- Recovery of valuable energy resources;
- VRU capacity: from 150 to 3500 m<sup>3</sup>/h of vapours.

Main application of VRU:

- Storage terminals;
- Truck and rail car loading;
- Marine loading system;
- Vapour balance systems.



# Vapour Recovery Unit

All emission regulations can be achieved:

TA-Luft: 150 mg/m<sup>3</sup>

EU Directive: 35 g/m<sup>3</sup>

US EPA: 5 mg/l loaded

Our VRU may even coupled with a second stage plant, reducing emissions to as low as 50 mg/m<sup>3</sup>.

Process consists of three main steps:

- ❖ Adsorption of the VOC on activated carbon bed;
- ❖ Regeneration of the carbon by means of vacuum;
- ❖ Re-absorption and recovery of VOC by absorbent liquid.



# Vapour Recovery Unit

## **VRU Safety**

Safety features of our VRUs include the following:

- Use of activated carbon capable to withstand high degrees of mechanical and thermal stresses;
- Higher pressure resistant vessels and piping;
- Control system monitoring all important operating parameters, with ESD;
- Flame arrestors, limit switches , level switches etc.

## **VRU Control system**

- Our plants are equipped with an advanced Programmable Logic Controller (PLC), a bus communication between I/O station and PLC as well as a PC-based, user-friendly Human Machine Interface (HMI). Control system continuously keeps track of process parameters and the operation of the unit;
- The system enables operational adjustments, accurate diagnostics and remote supervision.

